

BETAGAUGE

311A-Ex/321A-Ex

Reference Manual



**BETAGauge 311A-Ex/321A-Ex
Reference Manual**

1. Introduction	.1
1.1 Contacting Martel / Beta	.1
1.2 Standard Equipment	.1
1.3 Safety Information	.1
2. Calibrator Interface	.4
2.1 Calibrator Display	.5
2.2 Using the Backlight	.10
2.3 Using the Zero Function	.10
2.4 Other Menu Controlled Functions	.10
3. Measuring Pressure	.14
3.1 Media Compatibility	.14
4. Measuring Current	.15
5. Measuring Temperature with an RTD	.16
6. Performing a Pressure Switch Test	.17
7. Calibrating Transmitters	.19
7.1 Using the mA Input Function	.19
7.2 Calibrating a Pressure-to-Current Transmitter	.19
7.3 Percent Error Function	.20
8. Minimum and Maximum Storage Capability	.22
9. Factory Setups	.23
10. Custody Transfer / Flow Calibration	.24
11. Specifications	.25
12. Warranty	.26
13. Maintenance	.27
13.1 Replacing Batteries	.27
13.2 Cleaning the Unit	.28
13.3 Service Center Calibration or Repair	.28

1. Introduction

The BETA 311A-Ex/321A-Ex is designed to be a simple to use yet very versatile pressure calibrator. Its two internal pressure sensors combined with inputs for mA, switch contacts and an RTD probe allow the 311A-Ex/321A-Ex to calibrate virtually any pressure device.

The BetaGauge 311A-Ex is a single sensor pressure calibrator; the BetaGauge 321A-Ex is a dual sensor pressure calibrator. The 311A-Ex uses the P1 port for all pressure inputs. The P2 port is only used on the model 321A-Ex. Therefore on the model 311A-Ex, all menu choices involving pressure are limited to the P1 port only. All other model 311A-Ex features and functions are the same as for the 321A-Ex.

1.1 Customer Service

Corporate Office:

www.martelcorp.com

e-mail: sales@martelcorp.com

Tel: (603) 434-1433 800-821-0023 Fax: (603) 434-1653

Martel Electronics

3 Corporate Park Dr.

Derry, NH 03038

1.2 Standard Equipment

Check to see if your calibrator is complete. It should include: BETA 311A-Ex/321A-Ex Calibrator, instruction manual, Beta 321A-Ex/311A-Ex Concept Control Drawing (CCD), test leads, carrying case, calibration certificate with data.

1.3 Safety information

Ex Hazardous Areas

An Ex-hazardous area as used in this manual refers to an area made hazardous by the potential presence of flammable or explosive vapors. These areas are also referred to as hazardous locations.

The Model 321A-Ex calibrator has been designed for use in Ex Hazardous Areas. These are areas where potentially flammable or explosive vapors may occur. These areas are referred to as hazardous (classified) locations in the United States, as Hazardous Locations in Canada, as Potentially Explosive Atmospheres in Europe and as Explosive Gas Atmospheres by most of the rest of the world. The Model 321A-Ex calibrator is designed as intrinsically safe. This means that connecting the 321A-Ex calibrator to equipment that is used within intrinsically safe circuits will not cause an ignition capable arc as long as the entity parameters are suitably matched.















Warning

Check entity parameters before making any connections to this device.

Symbols Used

The following table lists the International Electrical Symbols. Some or all of these symbols may be used on the instrument or in this manual.

Symbol	Description
	AC (Alternating Current)
	AC-DC
	Battery
	CE Complies with European Union Directives
	DC
	Double Insulated
	Electric Shock
	Fuse
	PE Ground
	Hot Surface (Burn Hazard)
	Read the User's Manual (Important Information)
	Off
	On

The following definitions apply to the terms “Warning” and “Caution”.

- “Warning” identifies conditions and actions that may pose hazards to the user.
- “Caution” identifies conditions and actions that may damage the instrument being used.

Use the calibrator only as specified in this manual, otherwise injury and damage to the calibrator may occur.

 **Warning****To avoid possible electric shock or personal injury:**

- Do not apply more than the rated voltage. See specifications for supported ranges.
- Follow all equipment safety procedures.
- Never touch the probe to a voltage source when the test leads are plugged into the current terminals.
- Do not use the calibrator if it is damaged. Before you use the calibrator, inspect the case. Look for cracks or missing plastic. Pay particular attention to the insulation surrounding the connectors.
- Select the proper function and range for your measurement.
- Make sure the battery cover is closed and latched before you operate the calibrator.
- Remove test leads from the calibrator before you open the battery door.
- Inspect the test leads for damaged insulation or exposed metal. Check test leads continuity. Replace damaged test leads before you use the calibrator.
- When using the probes, keep your fingers away from the probe contacts. Keep your fingers behind the finger guards on the probes.
- Connect the common test lead before you connect the live test lead. When you disconnect test leads, disconnect the live test lead first.
- Do not use the calibrator if it operates abnormally. Protection may be impaired. When in doubt, have the calibrator serviced.
- Only operate the calibrator in non-hazardous areas or classified areas for which this device is certified to operate in.
- When measuring pressure, make sure the process pressure line is shut off and depressurized before you connect it or disconnect it from the pressure module.
- Disconnect test leads before changing to another measure or source function.
- When servicing the calibrator, use only specified replacement parts.
- To avoid false readings, which could lead to possible electric shock or personal injury, replace the battery as soon as the battery indicator appears.

 **Caution****To avoid possible damage to calibrator or to equipment under test:**

- Use the proper jacks, function, and range for your measurement or sourcing application.

2. Calibrator Interface

Figure 1 shows the location of the process measurement inputs, while table 1 describes their use.

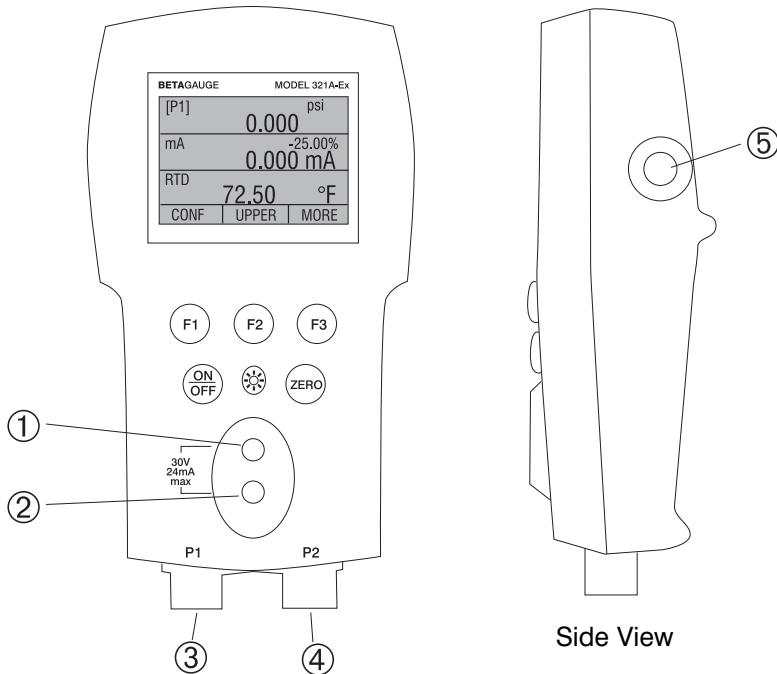

Figure 1
Pressure Measurement Inputs

Table 1 Process Measurement Inputs

No.	Name	Description
1, 2	Input Terminals	These terminal are used to measure current and a contact closure for switch test.
3	P1 Pressure Port	This is the connection for the internal sensor P1
4	P2 Pressure Port	This is the connection for the internal sensor P2
5	RTD Probe Connector	This connector is where the RTD probe is plugged in.

Figure 2 shows the location of the keys. Table 2 describes the function of each key.

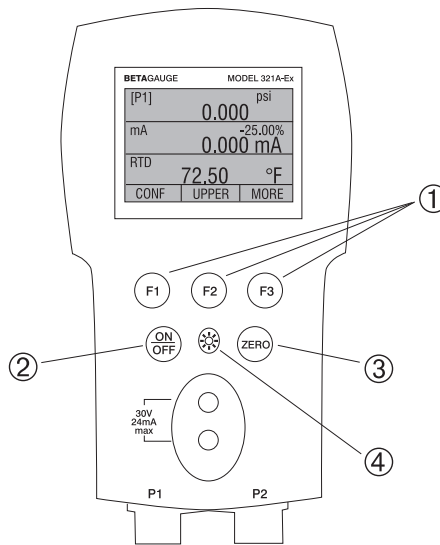

Figure 2
Keypad

Table 2 Key Functions

No.	Name	Description
1	Function Keys	These keys are used in various ways, primarily to configure the calibrator
2	ON/OFF Key	This key is used to turn the calibrator on and off
3	ZERO Key	This key is used to zero pressure measurements
4	Backlight Key	This key is used to turn the backlight on and off

Note: When the calibrator is turned on by pressing the ON/OFF key, it will go through a short startup self-check routine. During that routine, the display shows the current firmware revision level, auto shutdown status and the ranges of the 2 internal pressure sensors. The calibrator requires a maximum of 5 minutes warm-up to rated accuracy. Large changes in ambient temperature may require a longer warm-up period. See section 2.3 for instructions on zeroing the pressure sensor displays. Pressure ranges should be zeroed each time the calibrator is started.

2.1 Calibrator Display

The Calibrator Display consists of two regions: The menu bar (located along the bottom of the screen) is used to access a menu system. The main display (the rest) consists of up to three process measurement sub-regions. These sub-regions will henceforth be referred to as the UPPER, MIDDLE and LOWER displays. Figure 3 shows the location of the different display fields while table 3 describes them.

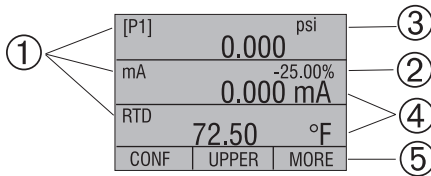

**Figure 3
Display**

Table 3 Display Functions

No.	Name	Description
1	Primary Parameters	Indicates what is being measured.
2	Span Indicator	Indicates the percent of the 4 to 20 mA span. (For mA functions only)
3	Pressure Units	Indicates one of 17 pressure units available for display.
4	Units	Indicates the unit of measure for the display.

2.1.1 Main Menu Functionality

There are three options on the Main Menu, CONFIG, {current display} and MORE. The Main Menu is home for the menu display.



2.1.1.1 Setting the Current Display

The current display is indicated by the center option on the Main Menu, pressing the F2 key will toggle the current display.

2.1.1.2 Setting Current Display Parameters

To set the parameters of the current display use the CONFIG option to get to the Display Configuration Menu.



Here the SELECT option will toggle through the choices for each parameter. The first parameter is MODE. Since current and switch test modes all use the same jacks, two of these functions cannot be used concurrently. The ability to select certain functions is limited based on what is already selected in another active display. The NEXT option is used to change to the second parameter. Only RTD and Pressure modes have a second parameter, RTDs can be read in Celsius or Fahrenheit and Pressures can be read in 11 engineering units.

With a single display the following modes are available:

- P[1] = Pressure on left side sensor.
- P[2] = Pressure on right side sensor.
- P[1] ST = Switch Test with left side sensor.

P[2] ST = Switch Test with right side sensor.

mA = Milliamps measure

RTD = RTD Temperature Measurement (if a probe is connected).

The following table shows which functions are available concurrently.

An X in a column indicates that the mode in the current display will not be available for selection if the mode in that row is in use in any other active display.

Table 4 Mode Concurrency

		CURRENT DISPLAY					
OTHER DISPLAYS		P[1]	P[2]	P[1] ST	P[2] ST	mA	RTD
	P[1]						
	P[2]						
	P[1]ST			X	X	X	
	P[2]ST			X	X	X	
	mA			X	X		
	RTD						

Note: P2 is only available on the model 321A-Ex.

2.1.1.3 Accessing Other Menus

Use the MORE option on the Main Menu to access the other menu functions.

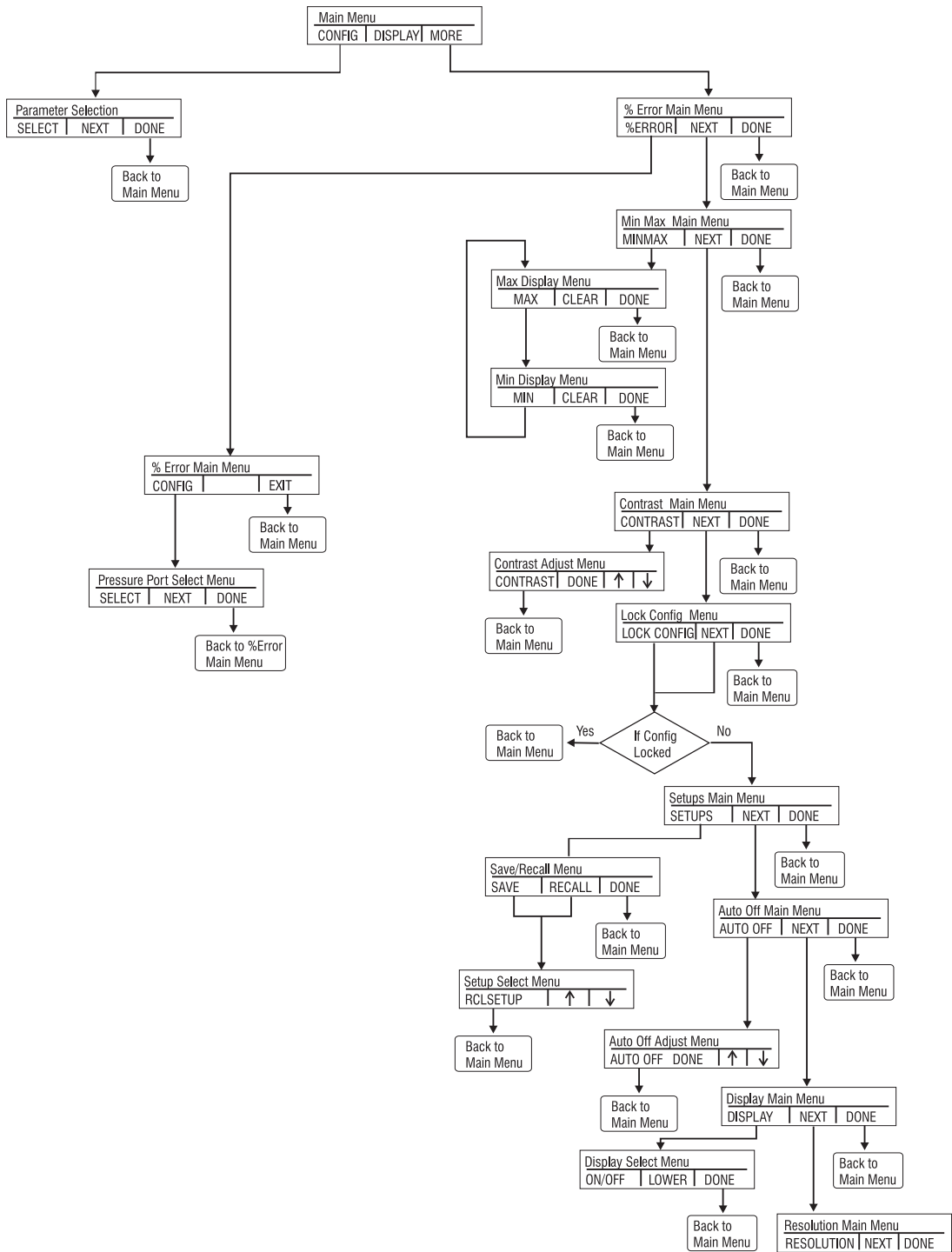

Continued on next page...

Figure 4
Menu Map

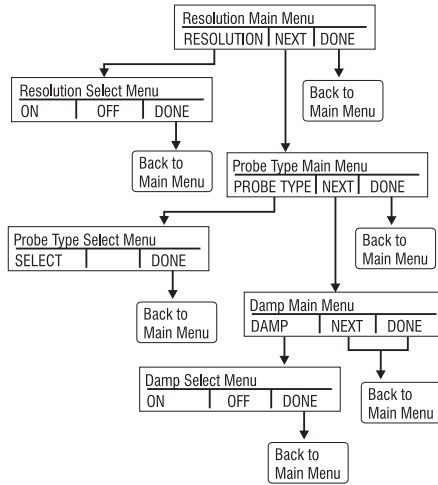

2.2 Using the Backlight

The backlight is controlled by the dedicated backlight key. It toggles on and off when the key is pressed; this is one of the few functions that cannot be controlled by the serial interface. There are no user configuration settings for the backlight.

2.3 Using the Zero Function

When the ZERO KEY is pressed, the calibrator will zero the current display if a pressure mode is selected, and the pressure is within the zero limit. The zero limits are within 5% of the full scale range of the selected sensor. If the display indicates “OL,” the zero function will not operate.”

2.3.1 Internal Sensor (non-absolute)

When a sensor or module is selected on the current display and the ZERO KEY is pressed the calibrator subtracts the current reading from the output. The zero limits are within 5% of the full scale range of the selected sensor. If the display indicates “OL,” the zero function will not operate.

2.3.2 Absolute Internal Sensor

When an absolute module is selected on the current display and the ZERO KEY is pressed, the calibrator prompts the user to either set or default the pressure reference.

PRESSURE REFERENCE		
14.612		
DEFAULT	SET	DONE

If the set option is selected, the calibrator prompts the user to enter the barometric reference pressure. This is done using the arrow keys (F2 and F3 keys). The sensor port should be open (vented) to atmosphere while performing this procedure.

PRESSURE REFERENCE		
14.612		
SET REF DONE	↑	↓

Alternately, if the DEFAULT option is selected, the user is asked to confirm the choice to go to factory default or cancel the request.

PRESSURE REFERENCE	

CONFIRM	CANCEL

2.4 Other Menu Controlled Functions

There are eight ‘sub-main’ menus that can be accessed through the MORE option of the Main Menu. A ‘sub-main’ menu contains three options. The first option is unique to the

function. The second and third options of a 'sub-main' menu are always the same. The NEXT option leads to the next 'sub-main' menu and the DONE option returns home . For the last 'sub-main' menu the NEXT option wraps around to home. See Figure 4 for a detailed mapping of the menu structure.

A note on naming convention:

If a 'sub-main' menu has subordinate menus, it will henceforth be referred to as {function} Main Menu. E.g. the display contrast sub-main menu will be called the Contrast Main Menu. If not it will be called the {function} menu.

2.4.1 Setting the Contrast

From the Contrast Main Menu choose the CONTRAST option to access the Contrast Adjustment Menu.



Use the arrow keys to adjust the display contrast to the desired level and then use the CONTRAST DONE option to return home.



2.4.2 Locking and Unlocking Configurations

Use the LOCK CFG or UNLOCK CFG option of the Configuration Lock Menu to lock or unlock the display configuration.



When the LOCK CFG option is chosen the menu display returns home and the CONFIG option on the Main Menu indicates that it is locked. Also all menus are locked out with the exception of the Contrast Adjustment menus and the Configuration Lock Menu. When the UNLOCK CFG option is chosen the configuration is unlocked and the menu display continues to the next sub-main menu.

2.4.3 Saving and Recalling Setups

The calibrator will automatically save the current set-up for recall at power-up. Additionally 5 set-ups can be accessed through the SETUPS menu. Select the SETUPS option from the Setups Main Menu.



Choose SAVE to save a set-up , RECALL to recall the set-up, or DONE to do nothing and return home.



If SAVE or RECALL is selected use the arrow keys to select the set-up location. Then use the save option to store the current set-up into the selected location or the recall option to

recall the set-up stored in the selected location. The display menu will automatically go home.

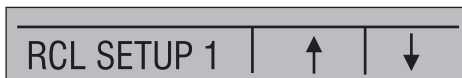

2.4.4 Setting AutoShut-off Parameters

The calibrator can be set to automatically shut-off after a selected number of minutes; this function can also be disabled. To set the auto shut off parameters select the AUTO OFF option on the Auto Shut Off Main Menu.



Use the arrow keys to select the number of minutes before the calibrator turns off or disable auto shut-off by scrolling all the way down.

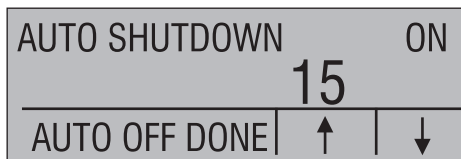

Use the AUTO OFF DONE option to set the parameters and return home. The auto shut off time is reset whenever a key is pressed.

2.4.5 Activating and Deactivating a Display

Use the DISPLAY option on the Display Selection Main Menu to access the Display Activation Menu.



The {function} option can be used to select which display to act upon. The ON/OFF option turns the selected display on or off. The selected display and current on/off state are displayed in the lower display.



Use the DONE option to save the changes and return home. When a display is deactivated its configuration is retained. When the display is activated its configuration is checked against the configurations of the other currently active displays, if the configurations are in conflict the recalled display's configuration is modified to avoid the conflict. If all three displays are deactivated the LOWER display will come on automatically

2.4.6 Low resolution function.

Due to the high accuracy of the 311A-Ex/321A-Ex the measured values are displayed with many digits, this might be an disadvantage in some cases, therefore the 311A-Ex/321A-Ex has a low resolution function. The function takes away the last digit.

To turn the function on or off, proceed as follows:

1. With the calibrator turned on and operating press the F3 key to activate the MORE menu option. Press the NEXT button until RESOLUTION appears in the left text field. Now press the F1 key to enter the function.

RESOLUTION	NEXT	DONE
------------	------	------

2. The select ON or OFF to turn the low resolution function on or off.

LO RESOLUTION			ON
ON	OFF	DONE	

3. Pressing DONE returns to main menu.

2.4.8 Setting the RTD probe type

Use the PROBE TYPE option of the RTD Probe Type main menu to access the RTD Probe selection menu.

PROBE TYPE	NEXT	DONE
------------	------	------

There are four probe types to select from P100-385, P100-392, P100-JIS and CUSTOM. Use the SELECT option to select the desired probe type and the DONE option to store the change and return home.

Note: The default probe type is PT100-385.

SELECT RTD PROBE TYPE		
P100-385		
SELECT		DONE

2.4.9 Damping

Damping can be turned ON or OFF using the Damping menu selection. When damping is ON, the calibrator displays an running average reading of ten measurements. The calibrator makes approximately 3 readings per second.

3. Measuring Pressure

To measure pressure, connect the calibrator using an appropriate fitting. Choose a pressure setting for the display being used. The calibrator is equipped with two internal sensors. Be sure to choose the sensor based on working pressures and accuracy.

Warning

Pressure sensors may be damaged and/or personnel injury may occur due to improper application of pressure. Please refer to the table of ranges and resolutions at the back of this manual for information on overpressure and burst pressure ratings. Vacuum should not be applied to any gauge pressure sensor. The calibrator display will indicate “OL” when an inappropriate pressure is applied. If “OL” is observed on any pressure display, the pressure should be reduced or vented immediately to prevent damage or possible personnel injury. “OL” is displayed when the pressure exceeds 120% of the nominal range of the sensor or when a vacuum in excess of 2 PSI is applied on gauge range sensors.

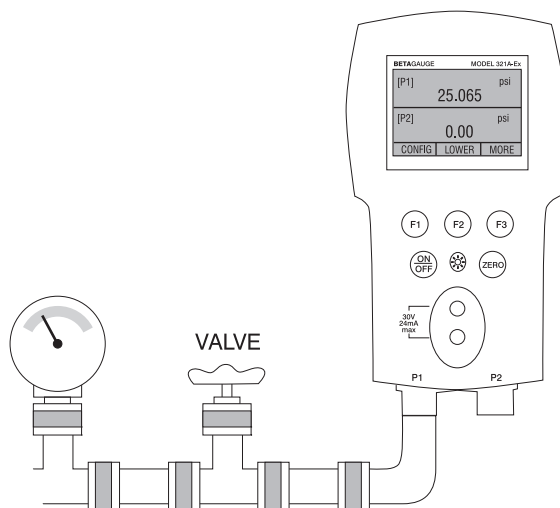

Figure 5

Use the (ZERO) key to zero the pressure sensor when vented to atmospheric pressure.

Important NOTE: To protect sensor integrity and prevent damage to the sensor, the calibrator will display OL [overload] when the applied pressure exceeds 120% of the full scale calibrated range of the sensor.

Important NOTE: To ensure accuracy of the calibrator it is critical to zero the calibrator before a device is calibrated.

3.1 Media Compatibility

The calibrator utilizes a media isolated sensor to prevent sensor contamination. Whenever possible clean, dry air is the media of choice. If that is not always possible, make sure that the media is compatible with Nickel Plated Brass and 316 Stainless Steel.

4. Measuring Current



Warning

Check entity parameters before making any connections to this device.

To measure current use the input terminals in the front of the calibrator. Select the mA function on one of the displays. Current is measured in mA and percentage of range. The range on the calibrator is set to 0% at 4 mA and 100% at 20 mA.

Note: The display will indicate “OL” when the measured current exceeds the nominal range of current measurement (24 milliAmps).

For example:

If the current measured is displayed as 75% then the mA value is 16 mA.

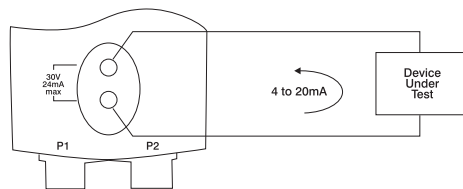
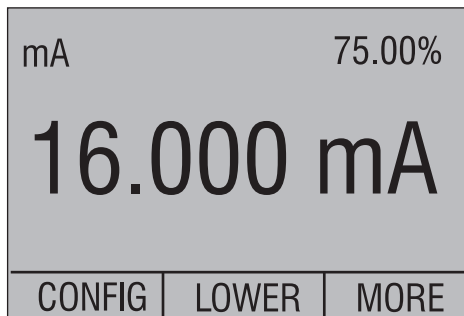

Figure 6

5. Measuring Temperature with an RTD

To measure temperature using an RTD probe you must select the RTD function on one of the displays. Make sure the proper probe type is selected. There are 4 probe types supported, P100-385, P100-392, P100-JIS and CUSTOM. The standard probe has a 9” insertion depth with a 3/16” diameter stainless steel sheath.

Note: The factory default type is PT100-385 so if the 311A-Ex/321A-Ex is being used with the Martel Model LPT100A probe you do not have to set the probe type. Simply plug the probe into the 311A-Ex/321A-Ex and configure the display to read temperature.

Note: The display will indicate “OL” when the measured temperature is outside the nominal measurement range of the RTD function (below -40°C or above 150°C).

If a custom probe is being used, the entering of R0 and coefficients is handled through the serial interface (see section 11).

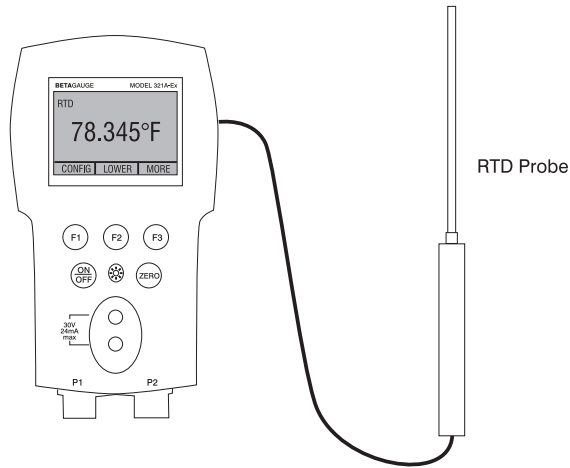

Figure 7

6. Performing a Pressure Switch Test



Warning

Check entity parameters before making any connections to this device.

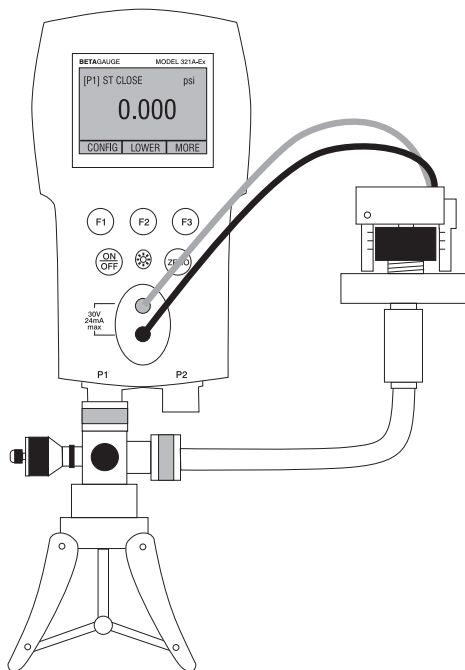

Figure 8

To perform a switch test, follow these steps:

1. Change the setup to Setup 4 (default switch test).

Setup 4: The upper display is set to [P1] ST, all other displays are off.

Important NOTE: The pressure Switch Test can be performed with the following functions [P1] ST, [P2] ST.

2. Connect the calibrator to the switch using the pressure switch terminals. The polarity of the terminals does not matter. Then connect the pump to the calibrator and the pressure switch.
3. Make sure the vent on the pump is open. Zero the calibrator if necessary. Close the vent after zeroing the calibrator.
4. The top of the display will read “CLOSE”.

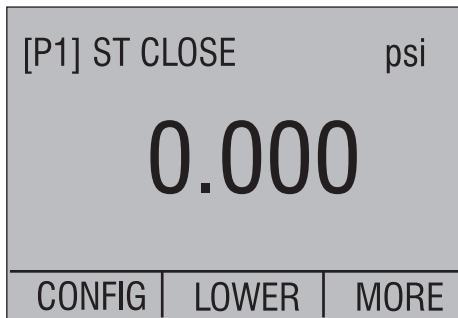

5. Apply pressure with the pump slowly until the switch opens.

Important NOTE: In the switch test mode the display update rate is increased to help capture changing pressure inputs. Even with this enhanced sample rate pressurizing the device under test should be done slowly to ensure accurate readings.

6. Once the switch is open, “OPEN” will be displayed, bleed the pump slowly until the pressure switch closes.

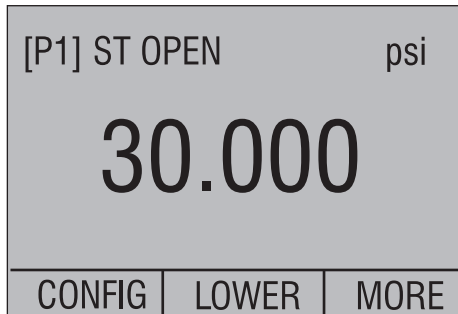

7. At the top of the display it will now read, “SW OPENED AT” and give you the pressure that the switch opened at.

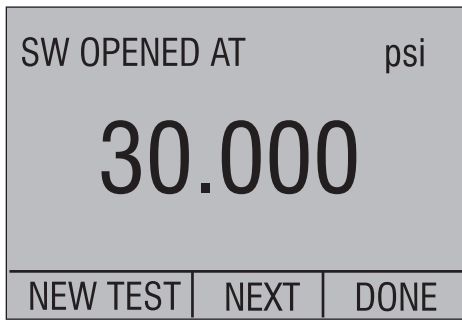

8. Press the “NEXT” option to view when the switch closed, and the dead band.

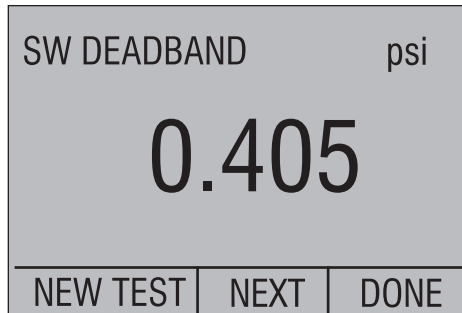
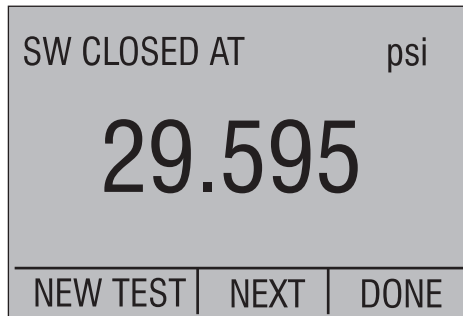

- 9. Press the “NEW TEST” option to clear the data and perform another test.
- 10. Press the “DONE” option to end the test and return to the standard pressure setting.

Example: [P1] ST will return to [P1].

Important NOTE: The previous example uses a normally closed switch. The basic procedure is still the same for a normally open switch, the display will just read “OPEN” instead of “CLOSE”.

7. Calibrating Transmitters



Warning

Check entity parameters before making any connections to this device.

7.1 Using the mA Input Function

The mA input function allows the user to read back the 4-20 mA output from the device being calibrated. This can be done passively – where the device under test directly generates 4-20 mA and can be read by the calibrator.

[P1]	psi	
30.000		
mA	100.00%	
20.000 mA		
CONFIG	LOWER	MORE

7.2 Calibrating a Pressure-to-Current Transmitter (P/I)

To calibrate a pressure-to-current transmitter (P/I), perform the following steps:

1. Connect the calibrator and the pump to the transmitter.
2. Apply pressure with the pump.
3. Measure the current output of the transmitter.
4. Ensure the reading is correct. If not, adjust the transmitter as necessary.



Check entity parameters before making any connections to this device.

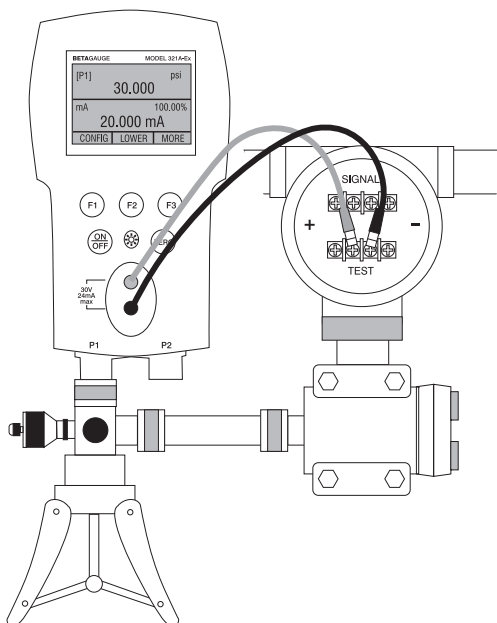

Figure 9.

7.3 Percent Error Function



Check entity parameters before making any connections to this device.

The calibrator features a unique function which can calculate pressure vs. milliamp error as a percentage of the 4 to 20 mA loop span. The percent error mode uses all 3 screens and has a unique menu structure. It simultaneously displays pressure, mA and percent error.

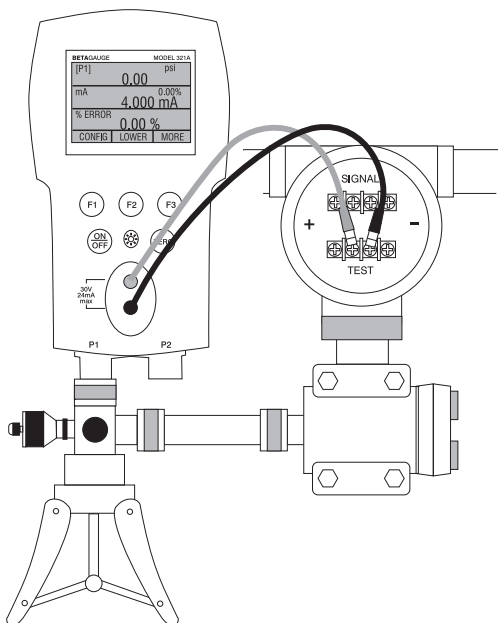

Figure 10.

Example:

Suppose a pressure transmitter under test is 30 psi (2 Bar) Full Scale and outputs a corresponding 4 to 20 mA signal. The user can program in a 0 to 30 psi pressure span into the calibrator and the calibrator will calculate and display the deviation or % Error from the expected 4 to 20 mA output. This eliminates the need for manual calculations and also helps if it becomes difficult to set an exact pressure with an external pump.

To use the %ERROR function proceed as follows:

1. With the calibrator turned on and operating press the F3 key to activate the MORE menu option. Now press the F1 key to activate the %ERROR option.
2. Press the F1 key to select the CONFIG option.
3. The first option is setting the Port, use the select option to scroll through the port choices, when finished select the NEXT option.

% ERROR PORT		[P1]
SELECT	NEXT	DONE

4. Use SELECT to toggle through the UNIT options, and select NEXT to move on.

SET UNIT		psi
SELECT	NEXT	DONE

5. Use the ↑ and ↓ arrows to set the 100% point of the desired pressure range, select DONE SET when finished.

SET 100% BELOW		psi
30.000		
DONE SET	↑	↓

6. Again, use the arrows to set 0% point and select DONE SET when finished and the %ERROR mode will be ready to use.

SET 0% BELOW		psi
0.000		
DONE SET	↑	↓

Note: The 0% and 100% point will be saved in non-volatile memory until they are changed again by the user for the internal sensors, and external pressure modules. When using an external module the 0% and 100% are set to low and full scale of the module until the user changes it, or if it was previously saved.

[P1]	0.0000	psi
[P2]	0.00	psi
RTD	85.78	°F
CONFIG	LOWER	MORE

8. Minimum and Maximum Storage Capability

The 300 Series Pressure Calibrators have a min/max feature for capturing the minimum and maximum values of any displayed parameter.

The min/max function can be accessed by stepping through the menu options until “min/max” is shown on the display above the F1 key. At this time, pressing the F1 key will toggle the display through the min/max values that are stored in the min/max registers. These readings are live so that the new min/max values will be recorded while in this mode.

To reset the min/max registers simply press the clear key. These registers are also cleared at power-up or when the configuration is changed.

[P1]	-0.003	psi
mA	4.000	-25.00%
MIN	CLEAR	DONE

[P1]	30.000	psi
mA	20.001	-25.00%
MAX	CLEAR	DONE

9. Factory Setups

The Calibrator is loaded with five factory setups. These setups are shown below.

Setup 1: The upper display is set to [P1] mode and the middle is set to mA, lower is off.

[P1]	psi	
30.000		
mA	100.00%	
20.000 mA		
CONFIG	UPPER	MORE

Setup 2: The upper display is set to [P2] mode and the middle is set to mA, lower is off.

[P2]	psi	
30.000		
mA	100.00%	
20.000 mA		
CONFIG	UPPER	MORE

Setup 3: The upper display is set to [P1] mode and the middle is set to [P2], lower is off.

[P1]	psi	
10.000		
[P2]	psi	
30.000		
CONFIG	UPPER	MORE

Setup 4: The lower display is set to [P1] switch test, the other displays are off.

[P1] ST CLOSE psi		
0.000		
CONFIG	LOWER	MORE

Setup 5: The upper display is set to [P1], the middle display is set to [P2] and the lower display is set to RTD.

[P1]	0.0000	psi
[P2]	0.00	psi
RTD	85.78	°F
CONFIG	LOWER	MORE

10. Custody Transfer / Flow Calibration



Check entity parameters before making any connections to this device.



The Model 311A-Ex/321A-Ex is ideal for flow computer calibration. Every manufacturer of flow computers has a different calibration procedure, but most call for calibration of three parameters: static pressure, differential pressure and temperature. To facilitate these measurements recall setup #5 on the 311A-Ex/321A-Ex.

Note: The pressures in the UPPER, and MIDDLE displays can be changed to [P1], [P2], and EXT.

1. Connect the calibrator to your static and differential pressures. ([P1], [P2]) Then connect the RTD sensor to the calibrator.
2. Using the reading of your RTD, static, and differential pressures make sure the flow computer has the correct reading. If not, adjust the flow computer as necessary.

11. Specifications (18 °C to 28 °C unless otherwise noted.)

General

Instrument Setup Recall	5; last used on power-up
Environmental Operating Temperature Storage Temperature	-10 °C to +45 °C -20 °C to +60 °C
Power Requirements Battery Battery Life	6.0 VDC Four (4) standard AA cells > 35 hours, typical usage
Physical Dimensions Weight	8.3" H x 3.9" W x 1.8" D (21.082 x 9.906 x 4.572 cm) 1 lb. 4 oz. (0.567 kg)
Product Compliance Markings	 Ex ia IIB T3 Gb (Ta=-10... +45°C)  KEMA 10 ATEX 0168X 0344 Ex ia IIB T3 Gb (Ta=-10... +45°C) II 2 G IECEx CSA 10.0013X Manufactured by Martel Electronics, Inc., 3 Corporate Park Dr. Derry, NH, USA
Entity Parameters	MEASUREMENT JACKS: Ui = 30 V; li = 80 mA; Pi = 750 mW; Ci = 0 μF; Li = 0 mH Uo = 7,14 V; lo = 1,12 mA; Po = 2 mW; Co = 240 μF; Lo = 1 H LEMO CONNECTOR: FOR USE WITH LTP100A RTD PROBE ONLY
EMI/RFI Conformance	EN6136, Annex A
Connectors/Ports	Pressure - two, 1/8" NPT BetaPort-P pressure module adapter; RTD probe
Included Accessories	Soft case, batteries, manual, NIST-traceable certificate, and test leads

Ranges

Available Pressure (select any two) Gauge: 0.3 psi, 1 psi, 5 psi, 15, psi, 30, psi, 100 psi, 300 psi, 500 psi, 1000 psi, 3000 psi, 5000 psi, 10,000 psi Absolute: 15 psi, 30 psi, 100 psi, 300 psi. Compound: -15 to 15 psi, -15 to 30 psi. (see table of ranges and resolutions for more information)	
mA	0 to 24.000 mA
RTD	-40.0°C to 150.0°C (-40.0°F to 302.0°F)
Engineering Units	psi, bar, mbar, kPa, MPa, kgcm2, mmH ₂ O @ 4°C, mmH ₂ O @ 20°C, cmH ₂ O @ 4°C, cmH ₂ O @ 20°C, inH ₂ O @ 4°C, inH ₂ O @ 20°C, inH ₂ O @ 60°F, mmHg @ 0°C, inHg @ 0°C

Accuracy

Pressure	
0.3 psi	±0.1% F.S.
1.0 psi	±0.05% F.S.
15 psi through 3000 psi	±0.025% F.S.
5 psi, 5000 psi, 10,000 psi	±0.035% F.S.
mA	±0.015% of rdg ±0.002mA
RTD (ohms)	±0.015% of rdg ±0.02 ohms; or ±0.1°C @ 0°C for Pt100
Temperature Effect	
No effect on accuracy on all functions from 15°C to 35°C	
Add ±0.002% F.S./°C for temps outside of 15°C to 35°C	
Optional LPT100A Probe	Meets PT-100 ALPHA 385 Class "A" Specifications

12. Warranty

Martel Electronics Corporation warrants all products against material defects and workmanship for a period of twelve (12) months after the date of shipment. Problems or defects that arise from misuse or abuse of the instrument are not covered. If any product is to be returned, a "Return Material Authorization" form can be obtained from our website www.martelcorp.com under customer service. You can also call 1-800-821-0023 to have a form faxed. Martel will not be responsible for damage as a result of poor return packaging. Out of warranty repairs and recalibration will be subject to specific charges. Under no circumstances will Martel Electronics be liable for any device or circumstance beyond the value of the product.

13. Maintenance

13.1 Replacing Batteries

Replace batteries as soon as the battery indicator turns on to avoid false measurements. If the batteries discharge too deeply the 311A-Ex/321A-Ex will automatically shut down to avoid battery leakage.

Note: Use only AA size alkaline batteries.



Only change batteries in an area known to be non-hazardous.

Approved Batteries

Battery Manufacturer (All Batteries Alkaline - A 1.5 V)	Type
Duracell	MN1500
Rayovac	Max Plus 815
Eveready (Energizer)	E91
Panasonic	LR6XWA

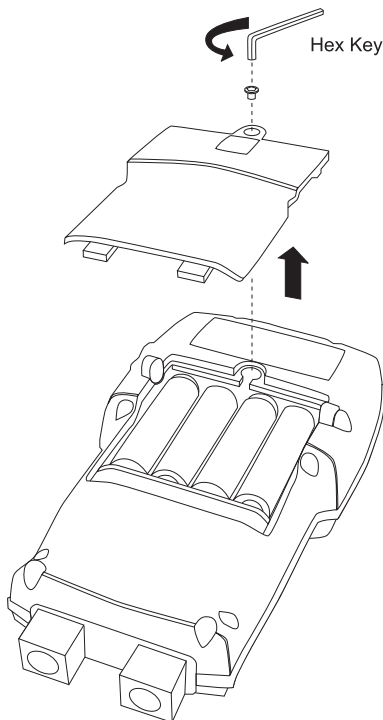

13.2 Cleaning the Unit

Warning

To avoid personal injury or damage to the calibrator, do not allow water into the case.

Caution

To avoid damaging the plastic lens and case, do not use solvents or abrasive cleansers. Clean the calibrator with a soft cloth dampened with water or water and mild soap.

13.3 Service Center Calibration or Repair

Only qualified service personnel should perform calibration, repairs, or servicing not covered in this manual. If the calibrator fails, check the batteries first, and replace them if needed.

Verify that the calibrator is being operated as explained in this manual. If the calibrator is faulty, call for an RMA number or go to www.martelcorp.com to download an RMA form to return the unit. Be sure to pack the calibrator securely, using the original shipping container if it is available.

BETAGauge 311A-Ex/321A-Ex Ranges and Resolutions

Range (psi)	0.4 (10"H2O)	1	5	7 (200"H2O)	15	15	30	30	30	100	300	500	1000	1500	3000	5000	10000
Burst Pressure (psi)	3	10	15	30	300	90	300	1000	1000	1000	2000	2000	10000	10000	10000	10000	15000
Proof Pressure (psi)	1	3	10	15	60	30	60	200	200	200	600	1000	3000	3000	6000	10000	15000
Static Pressure (psi)	1	100	100	100	NA	NA	NA	NA	NA	NA	NA	NA	NA	NA	NA	NA	NA
Sensor Type	non-isolated differential	non-isolated differential	non-isolated differential	non-isolated differential	isolated gauge	non-isolated compound	isolated gauge	non-isolated compound	non-isolated compound	isolated compound	isolated compound	isolated compound	isolated gauge	isolated gauge	isolated gauge	isolated gauge	isolated
Range Type	differential	compound	compound	compound		absolute		absolute	absolute	absolute	absolute						
psi	1	1.0000	5.0000	7.0000	15.000	15.000	30.000	100.00	30.000	100.00	300.00	500.00	1000.0	1500.0	3000.0	5000.0	10000
bar	0.06894757	0.0689	0.3447	0.4826	1.0342	1.0342	2.0684	6.8948	2.0684	6.8948	20.684	34.474	68.948	103.42	206.84	344.74	689.48
mbar	68.94757	27.579	344.74	482.63	1034.2	1034.2	2068.4	6894.8	2068.4	6894.8	20684	34474	68948	10342	20684	34474	68948
kPa	6.894757	2.7579	34.474	48.263	103.42	103.42	206.84	689.48	206.84	689.48	2068.4	3447.4	6894.8	10342	20684	34474	68948
MPa	0.006894757	0.0028	0.0345	0.0483	0.1034	0.1034	0.2068	0.6895	0.2068	0.6895	2.0684	3.4474	6.8948	10.342	20.684	34.474	68.948
kg/cm2	0.07030697	0.0281	0.3515	0.4921	1.0546	1.0546	2.1092	7.0307	2.1092	7.0307	21.092	35.153	70.307	105.46	210.92	351.53	703.07
cmH2O@4°C	70.3089	28.124	70.309	492.16	1054.6	1054.6	2109.3	7030.9	2109.3	7030.9	21093	35154	70309	10546	21092	351.53	703.07
cmH2O@20°C	70.4336	28.173	70.434	493.04	1056.5	1056.5	2113.0	7043.4	2113.0	7043.4	21130	35217	70434	10546	21092	351.53	703.07
mmH2O@4°C	703.089	281.24	703.09	4921.6	10546	10546	21093	70309	21093	70309	NA	NA	NA	NA	NA	NA	NA
mmH2O@20°C	704.336	281.73	704.34	4930.4	10565	10565	21130	70434	21130	70434	NA	NA	NA	NA	NA	NA	NA
inH2O@4°C	27.68067	11.072	27.681	193.76	415.21	415.21	830.42	2768.1	830.42	2768.1	8304.2	13840	27681	41521	83042	13840	27681
inH2O@20°C	27.72977	11.092	27.730	194.11	415.95	415.95	831.89	2773.0	831.89	2773.0	8318.9	13865	27730	41595	83189	13865	27730
inH2O@60°F	27.70759	11.083	27.708	193.95	415.61	415.61	831.23	2770.8	831.23	2770.8	8312.3	13854	27708	41561	83123	13854	27708
mmHg@0°C	51.71507	20.686	51.715	362.01	775.73	775.73	1551.5	5171.5	1551.5	5171.5	15515	25858	51715	77573	15515	25858	51715
inHg@0°C	2.03603	0.8144	2.0360	14.252	30.540	30.540	61.081	203.60	61.081	203.60	610.81	1018.0	2036.0	3054.0	6108.1	10180	20360
ftH2O@60°F	2.308965833	0.9236	2.3090	16.163	34.634	34.634	69.269	230.90	69.269	230.90	692.69	1154.5	2309.0	3463.4	6926.9	11545	23090

Proof Pressure - maximum allowable pressure without a shift in calibration

Burst Pressure - sensor damaged or destroyed; some risk of personal injury

Static Pressure - Differential units only. Maximum allowed common mode pressure between both ports.



www.martelcorp.com
e-mail: sales@martelcorp.com
Tel: (603) 434-1433 800-821-0023
Fax: (603) 434-1653

Martel Electronics
3 Corporate Park Dr.
Derry, NH 03038